

template catalog

Templates shown in this catalog are the most popular templates ordered.. For a more expansive library, shipping lead times, and pricing please visit our website at www.streetprint.com. For custom template options please call 1.800.688.5652

Popular Patterns

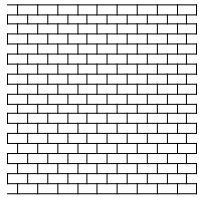

**Offset
Brick**
Section 1.0

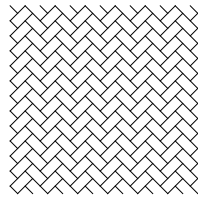

**Diagonal
Herringbone**
Section 2.0

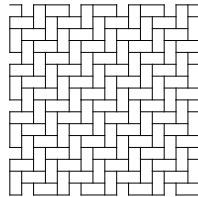

**Standard
Herringbone**
Section 3.0

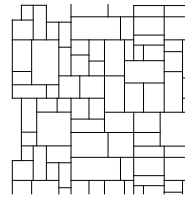

**Ashlar
Slate**
Section 4.0

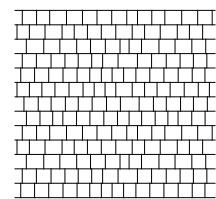

**British
Cobble**
Section 5.0

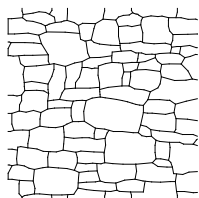

**Stone
Templates**
Section 6.0

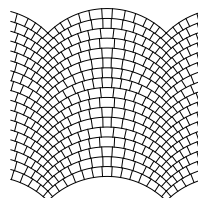

**Eurofan
Templates**
Section 7.0

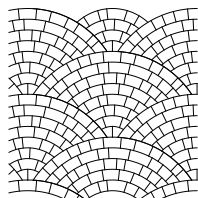

**Scallop
Templates**
Section 8.0

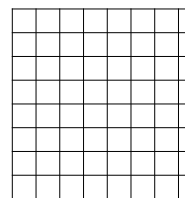

**Tile
Sets**
Section 9.0

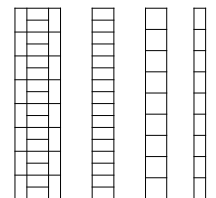

**Border
Templates**
Section 10.0

Special Purpose

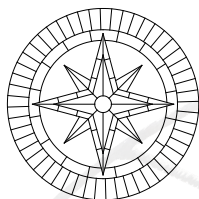

**Accent
Templates**
Section 11.0

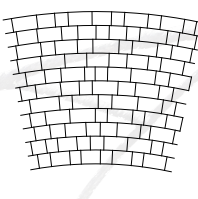

**Radial &
Arch Extensions**
Section 12.0

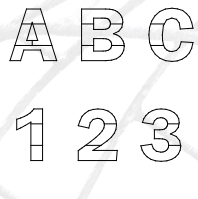

**Numbers &
Letters**
Section 13.0

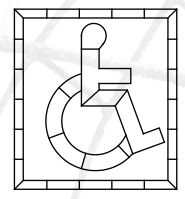

**Signage &
Playground**
Section 14.0

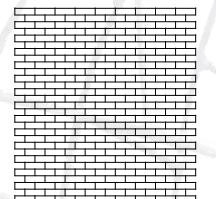

**International
Templates**
Section 15.0

When you see these symbols

Interlocking

means template interlocks on one or more sides -standard practice with use of StreetHeat equipment

end-to-end

means template fits end to end - ideal for behind a paver or printing 2 templates at once

SR-120

template sized for a SR-120

SR-60

template sized for a SR-60

SR-20

template sized for a SR-20

paver

template can be used behind a paver

offset brick

Our newest version of the classic, offset brick patterned template, designed for optimal use with the **SR-120**. These templates can be used in the StreetPrint® and TrafficPatterns XD™ applications. These templates allows for easy layout regardless of pattern direction.

SR-120

all sides

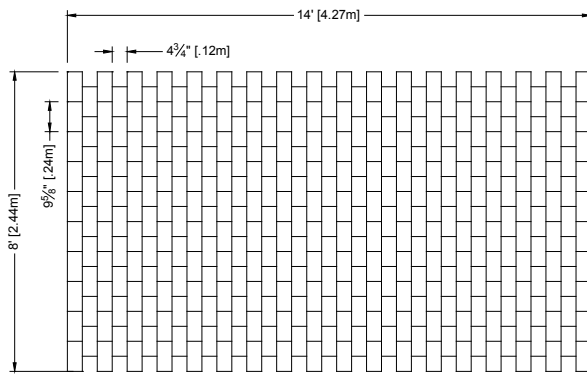

10-100

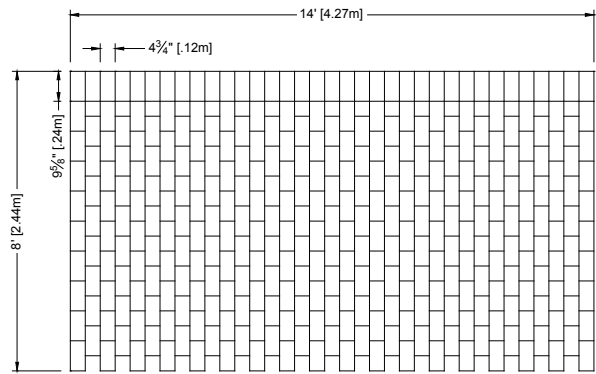

10-102

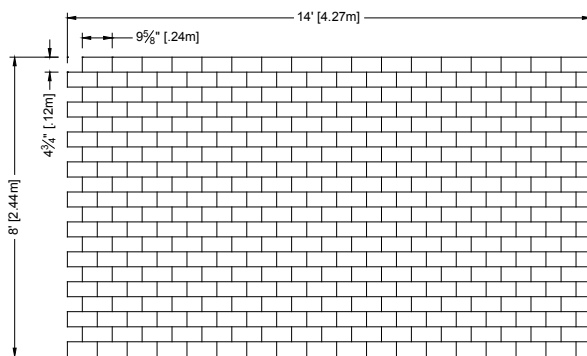

10-101

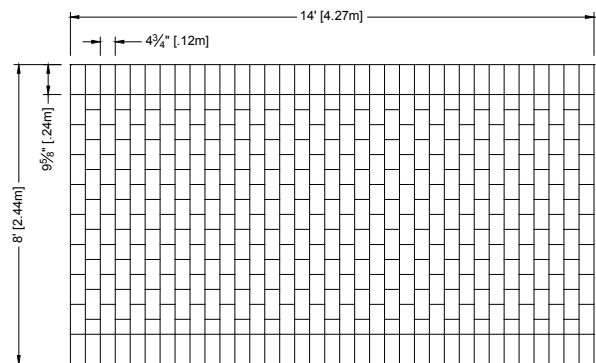

10-103

offset brick

The **SR-60** sized templates have been optimized to be used in the StreetPrint® and TrafficPatterns XD™ applications. These templates allows for easy layout regardless of pattern direction.

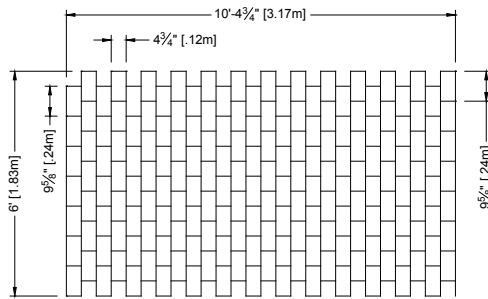

10-104

SR-60 all sides

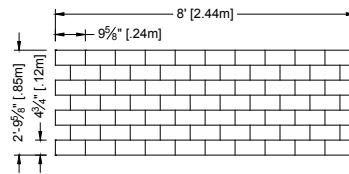

10-111

SR-20 all sides

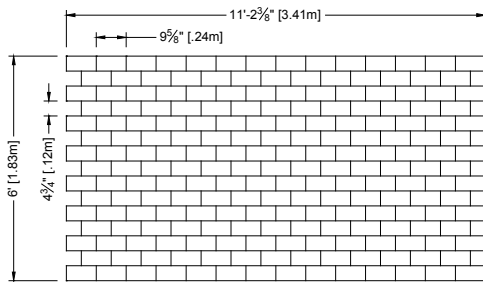

10-105

SR-60 all sides

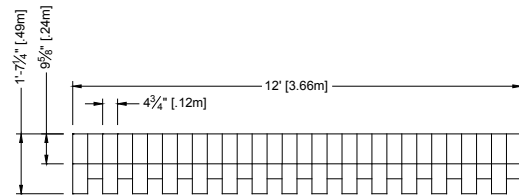

10-110

any SR all sides

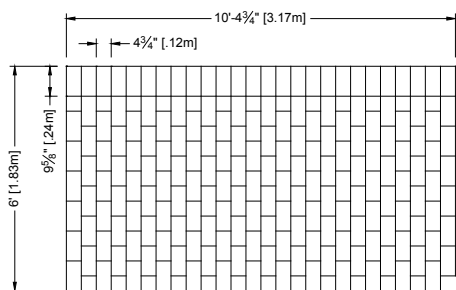

10-106

SR-60 all sides

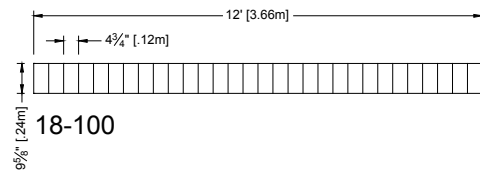

18-100

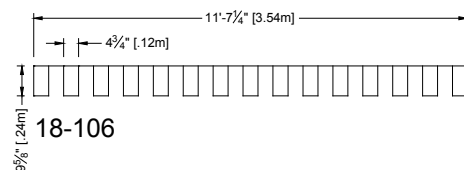

18-106

diagonal herringbone

This remarkably versatile, diagonal herringbone template is designed for optimal use with the **SR-120**. It can be used in either the StreetPrint® and TrafficPatternsXD™ applications and it is compatible with the previous series of diagonal herringbone templates

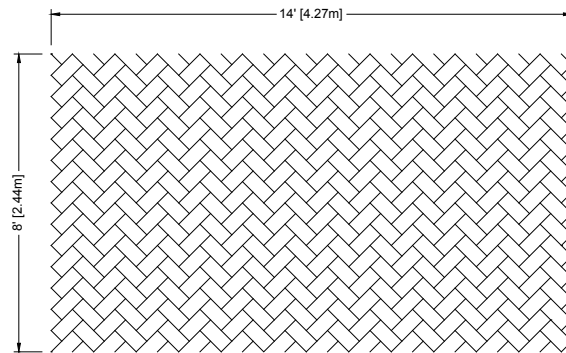

12-101

SR-120 14' sides only all sides

Typical Brick Size: 4 7/8" [12.32m] x 9 3/4" [24.63cm]

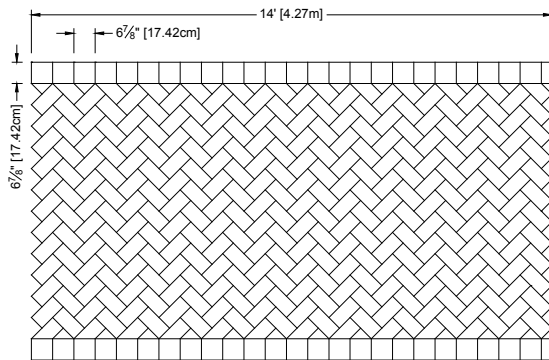

12-103

SR-120 all sides

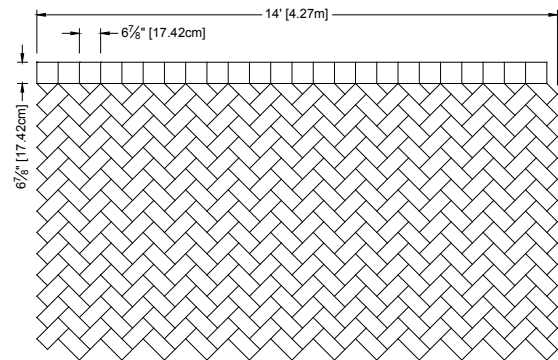

12-102

SR-120 all sides

diagonal herringbone

This remarkably versatile, diagonal herringbone template is designed for optimal use with the **SR-60**. It can be used in either the StreetPrint® and TrafficPatternsXD™ applications and it is compatible with the previous series of diagonal herringbone templates

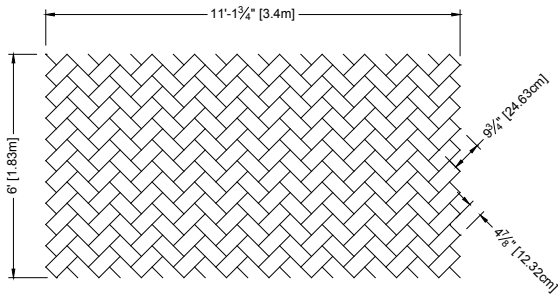

12-104

SR-60 11' sides only all sides

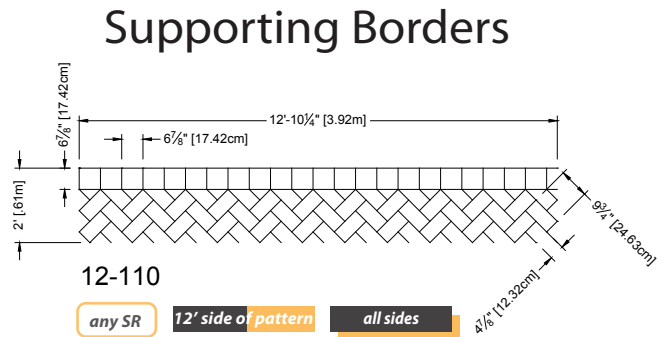

Supporting Borders

12-110

any SR 12' side of pattern all sides

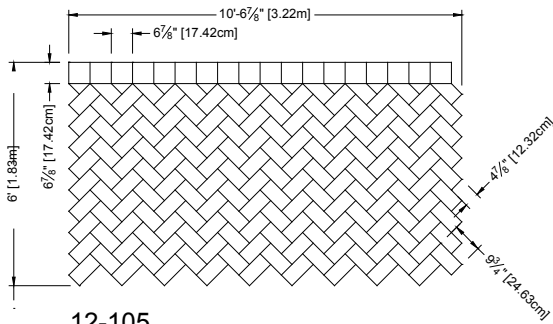

12-105

SR-60 all sides

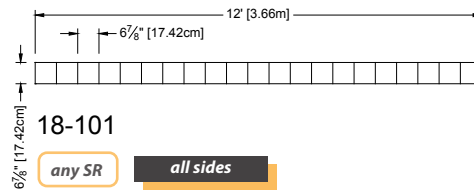

18-101

any SR all sides

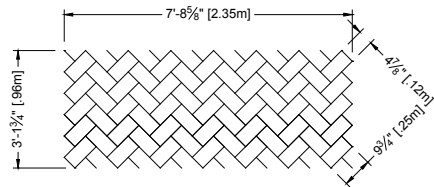

12-111

SR-20 7' side only all sides

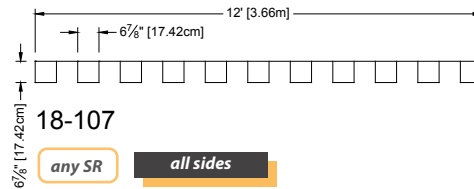

18-107

any SR all sides

standard herringbone

Classic standard Herringbone pattern designed to fit end-to-end **and** interlock on all sides

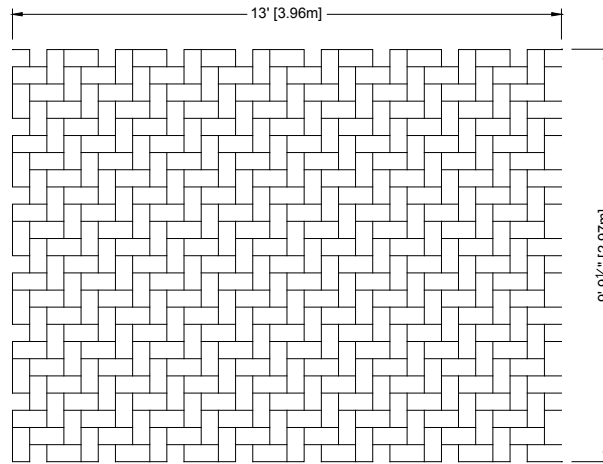

11-120-120

SR-120 all sides all sides

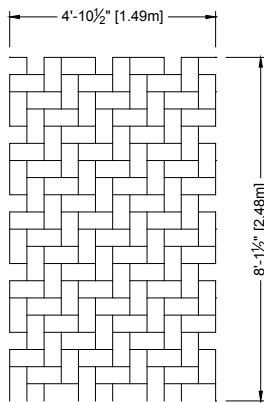

11-1-121

SR-60 all sides all sides

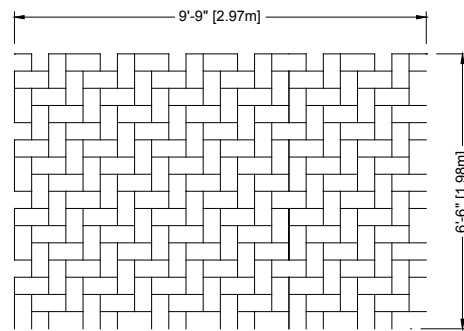

11-1-219

SR-60 all sides all sides

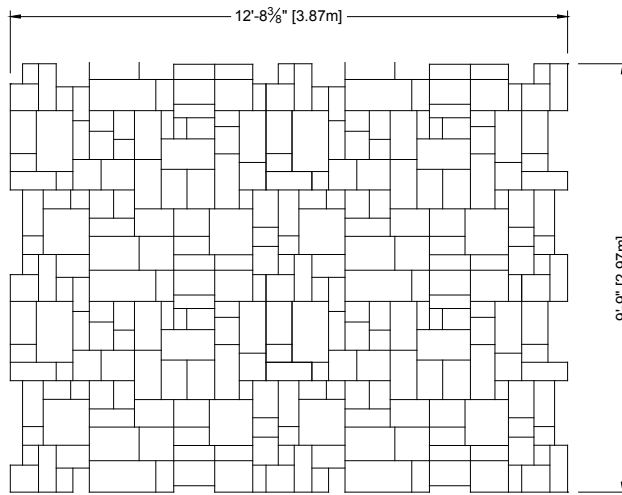

13-120-146

SR-120

all sides

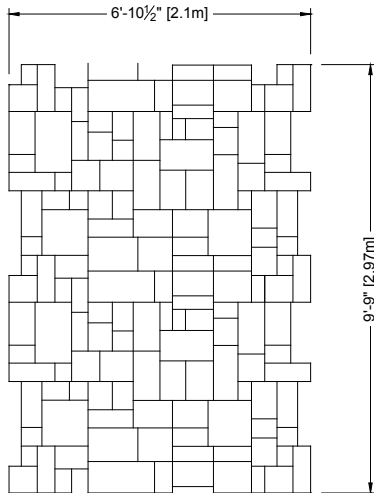

13-61-399

SR-60

all sides

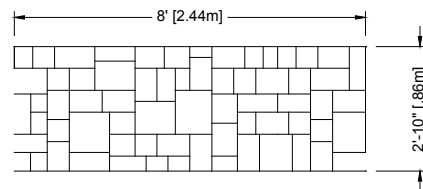

13-111

SR-20

3' sides only

british
cobble

Section
5.0

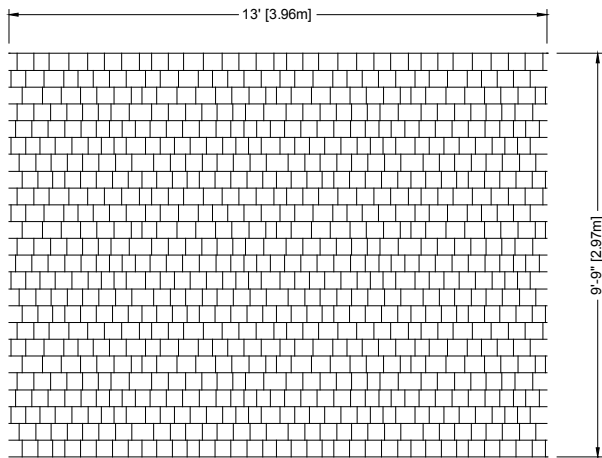

14-120-149

SR-120

all sides

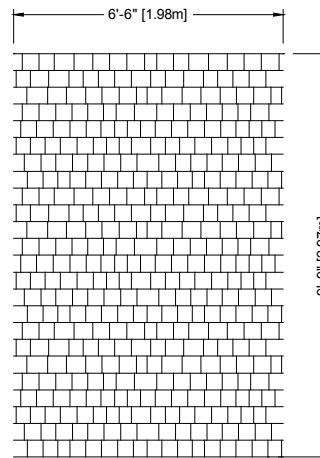

14-1-150

SR-60

all sides

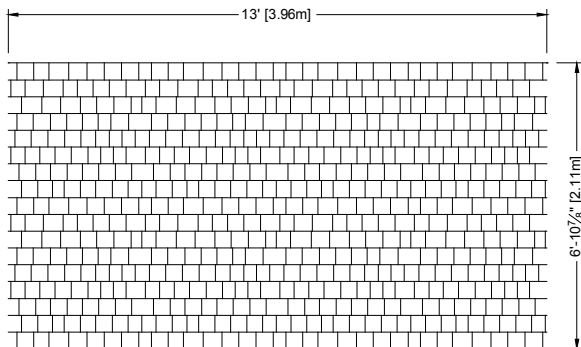

14-1-149

SR-120

7' sides

13' sides

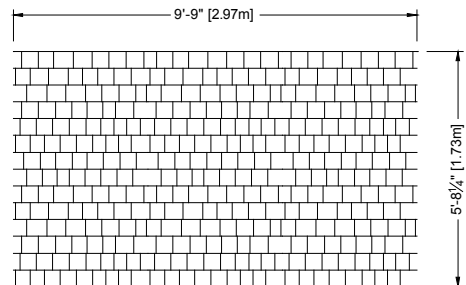

14-61-387

SR-60

all sides

stone templates

Random Slate

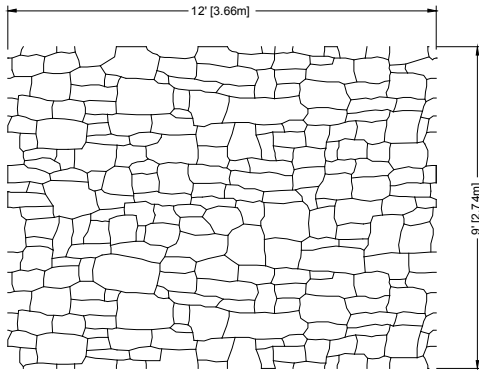

28-120-374

paver SR-120 all sides

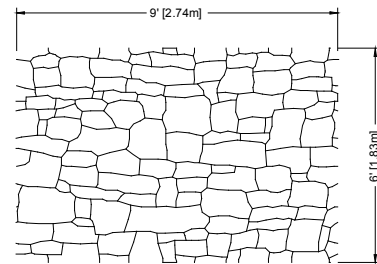

28-1-375

paver SR-60 all sides

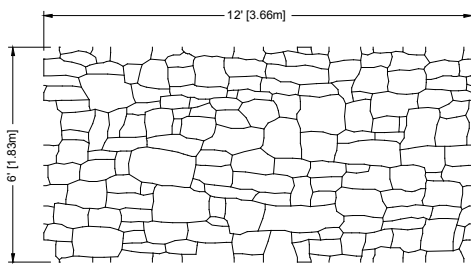

28-1-374

paver SR-120 all sides

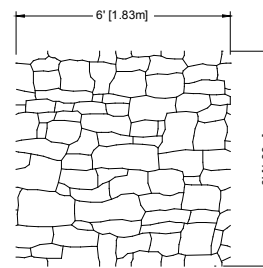

28-1-376

SR-60 all sides

stone templates

Thompson
Stone

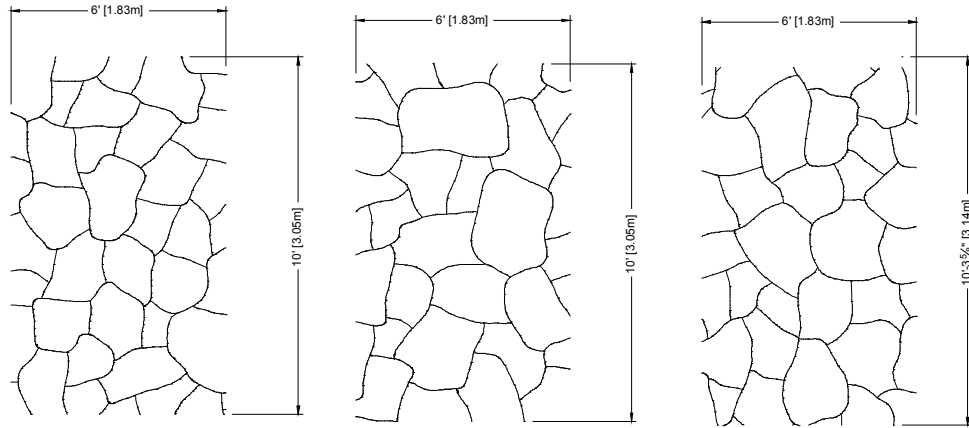

28-1-378 (set of 3)

paver

SR-60

all sides

Stone

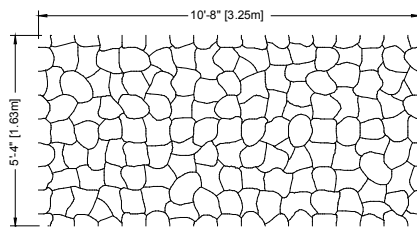

21-1-252

paver

SR-120

all sides

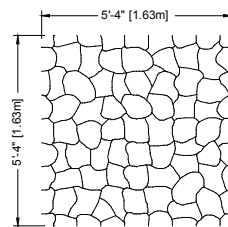

21-1-253

SR-60

all sides

stone
templates

Random Cobble

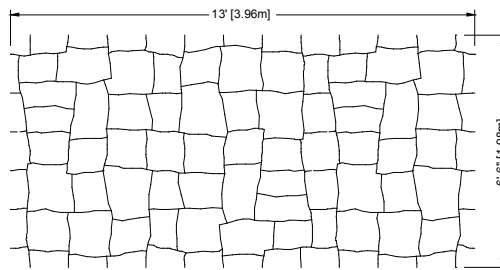

24-3-319

SR-120

paver

all sides

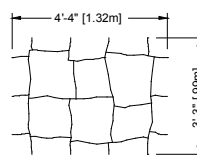
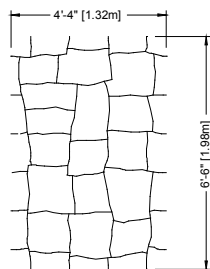

24-3-321

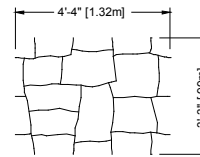

24-3-322

24-3-320

SR-60

all sides

eurofan
templates

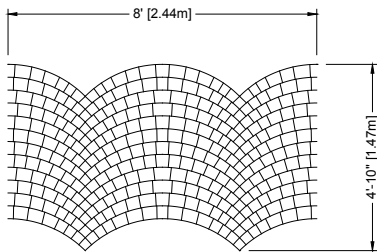

16-1-156

SR-60 4' sides only 8' sides, 2 rows

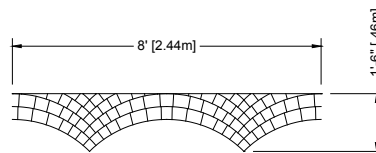

16-1-158 Top Edger

SR-60 SR-20 1' sides 8' side, curved wire

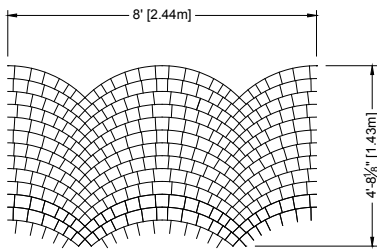

16-1-297

paver SR-60 all sides

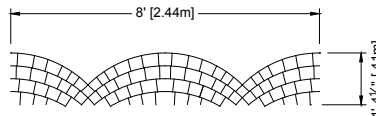

16-1-159 Bottom Edger

SR-60 SR-20 1' sides 8' side, curved wire

scallop templates

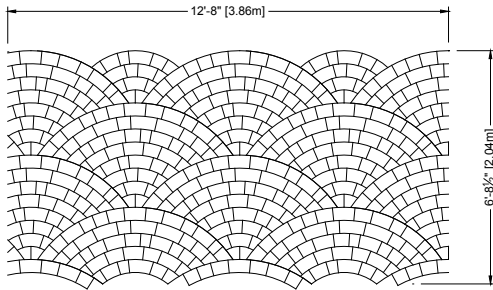

21-1-370

SR-120 6' sides only 12' sides, one row

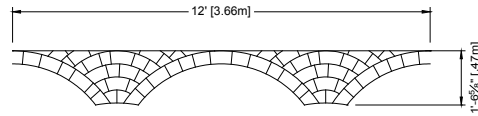

21-1-372 Top Edger

any SR 1' sides only 12' side, bottom row

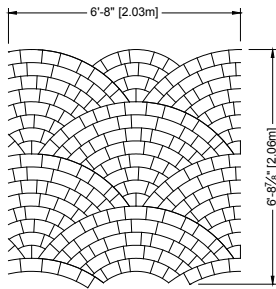

21-1-377

SR-60 6' sides only 6' sides, one row

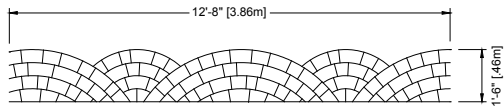

21-1-373 Bottom Edger

any SR 1' sides only 12' side, top row

4"
Tile

SR-60

all sides

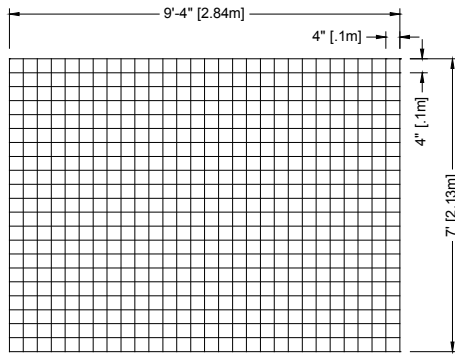

20-61-258

6"
Tile

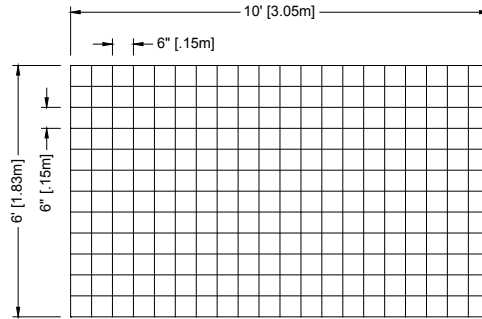

20-101

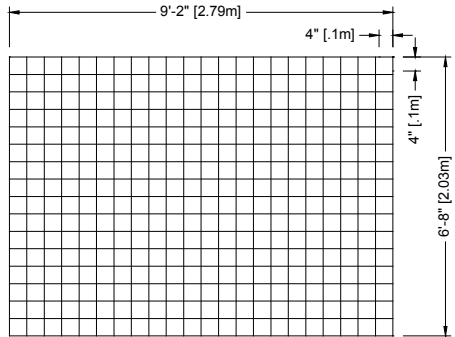

20-61-259

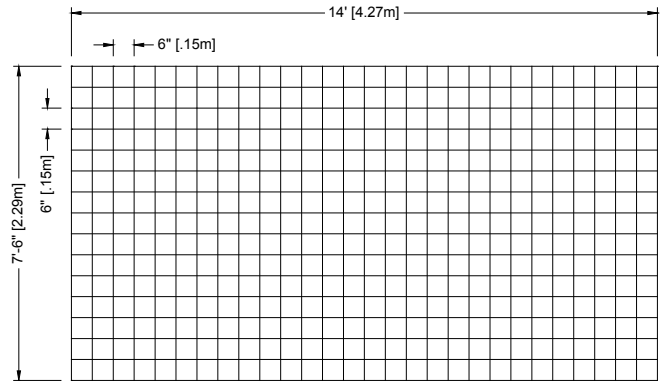

20-102

SR-120

all sides

5"
Tile

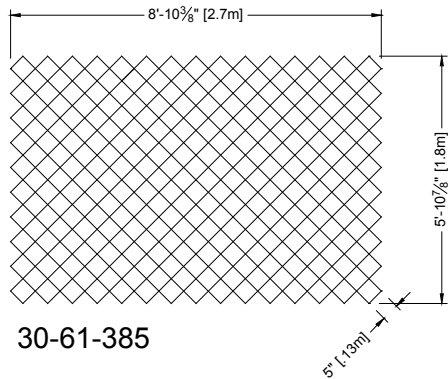

30-61-385

SR-60

all sides

8"
Tile

10"
Tile

Section
9.1

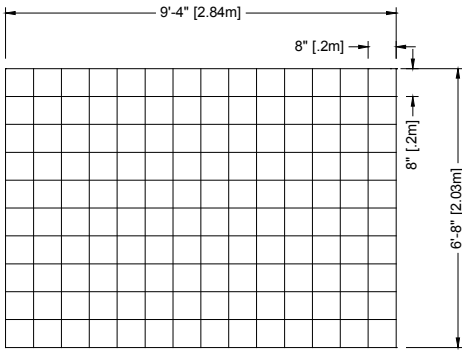

20-61-261

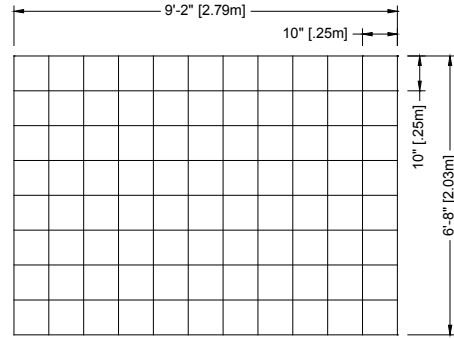

20-61-262

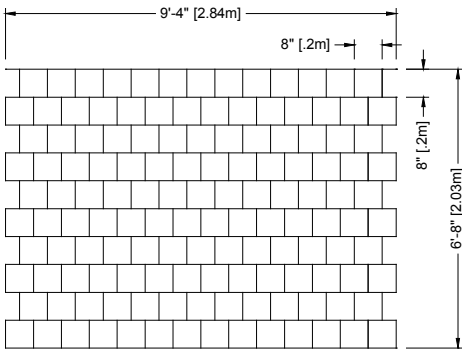

20-61-500

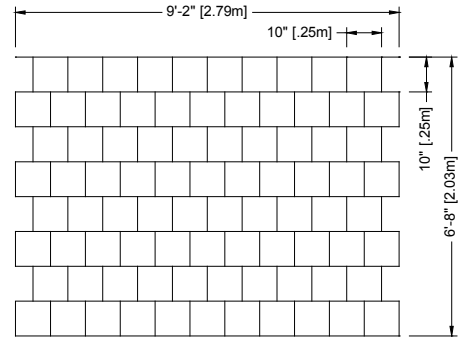

20-61-502

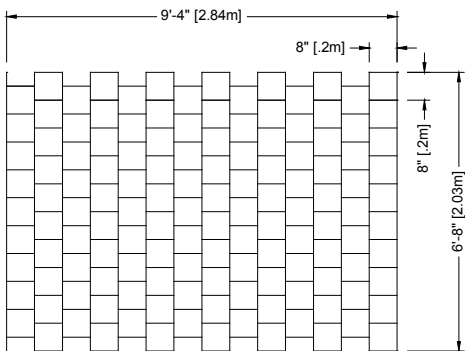

20-61-501

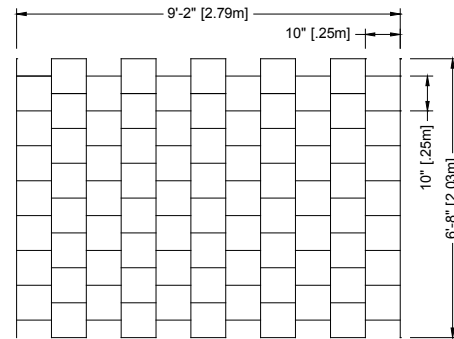

20-61-503

SR-60

all sides

12"
Tile

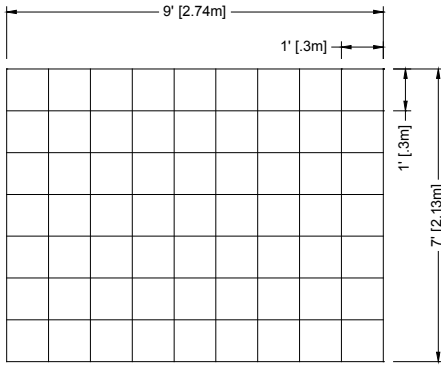

20-61-263

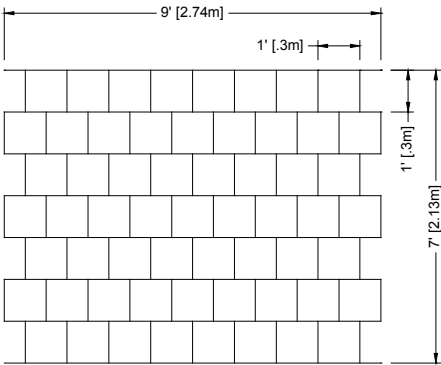

20-61-504

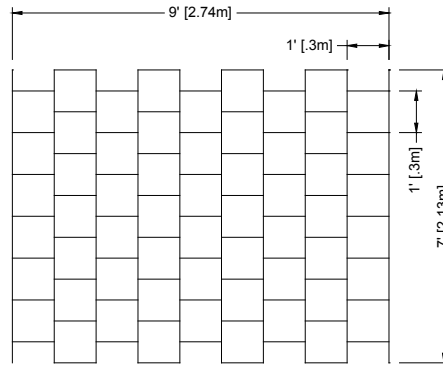

20-61-505

border templates

any SR

all ends

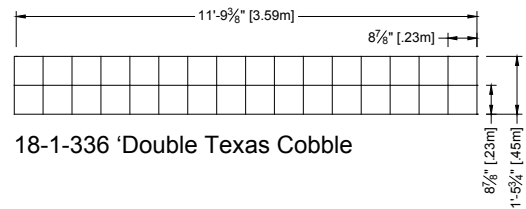
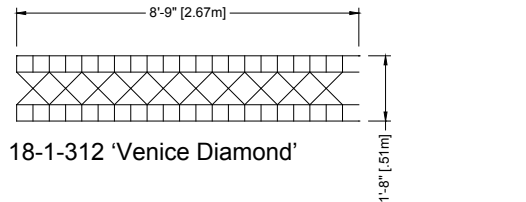
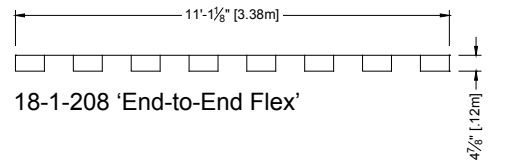
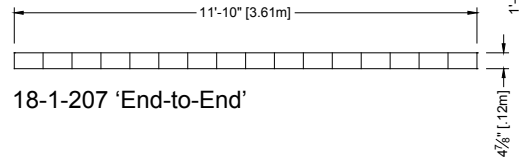
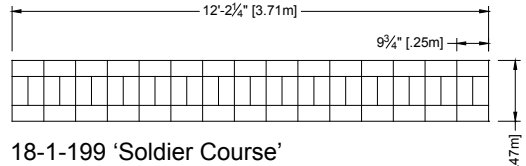
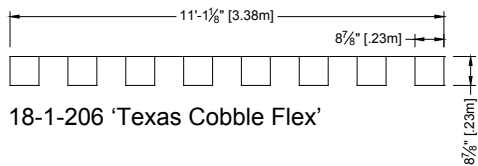
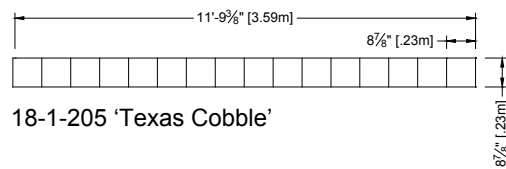
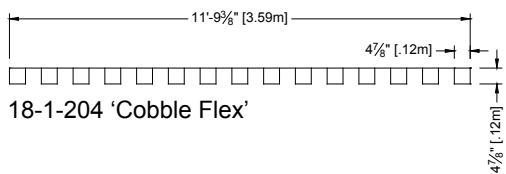
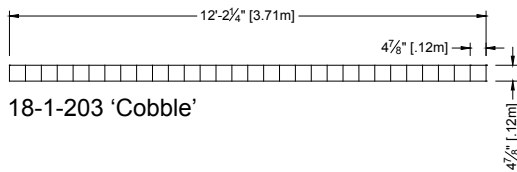
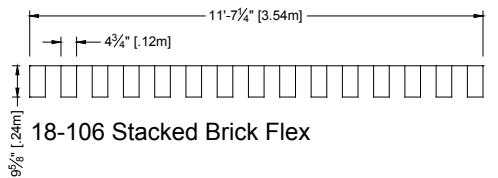
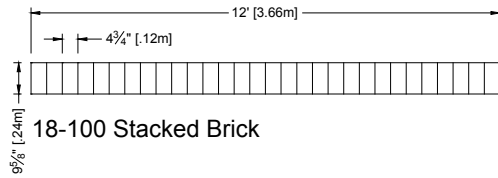

accent templates

Our new "Mini Accent" series was designed for the **SR-20** and to be inter-changeable with different borders and inserts to create different medallion combinations for driveways and or storefronts.

SR-20

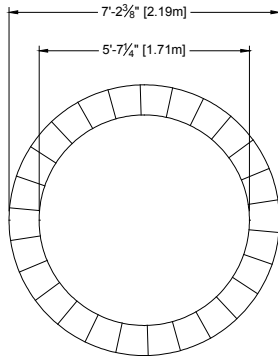

17-100
Texas Cobble Circle Border

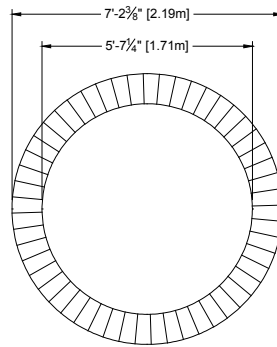

17-101
Stacked Brick Circle Border

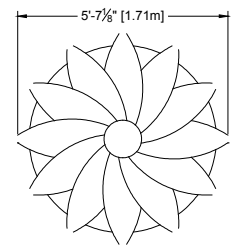

17-113
Pinwheel Insert

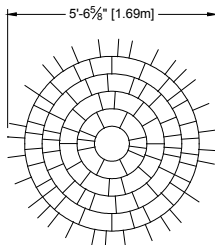

17-110
Cobble Insert

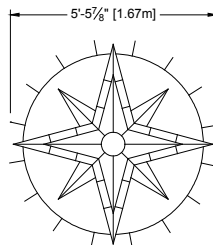

17-111
Compass Rose Insert

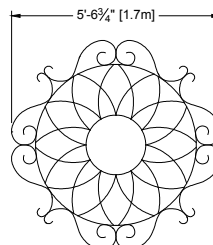

17-112
Ornate Rose Insert

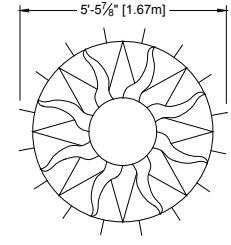

17-114
Sunburst Insert

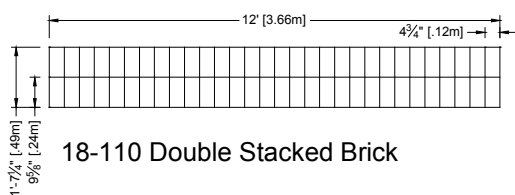

18-110 Double Stacked Brick

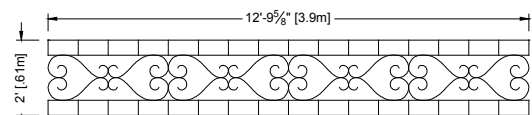

18-112 Ornate Border

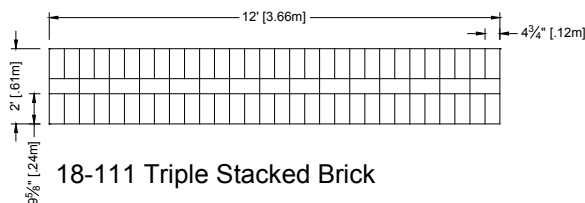

18-111 Triple Stacked Brick

Other compatible templates that may be used:

- 18-100 Stacked Brick Border
- 18-106 Stacked Brick Border Flex
- 18-1-205 Texas Cobble Border
- 18-1-206 Texas Cobble Border Flex
- 18-1-336 Double Texas Cobble Border
- 10-111 Offset Brick Pattern
- 12-111 Diagonal Herringbone Pattern
- 13-111 Ashlar Slate Pattern

radial & arch extensions

Section 12.0

SR-60

open sides

Product No.
17-1-162

Description
Large Circle 5' Radius

Brick Size
Random x 4⁷/₈"
(12.4 cm)

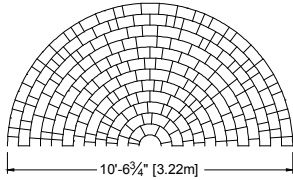

Product No.
17-1-163

Description
Medium Circle 3' Radius

Brick Size
Random x 4⁷/₈"
(12.4 cm)

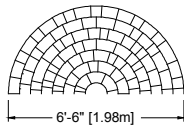

Product No.
17-1-269

Description
Arch Extension #3

Brick Size
Random x 4⁷/₈"
(x 12.4cm)

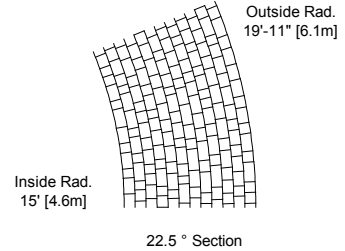

Product No.
17-1-270

Description
Arch Extension #4

Brick Size
Random x 4⁷/₈"
(x 12.4cm)

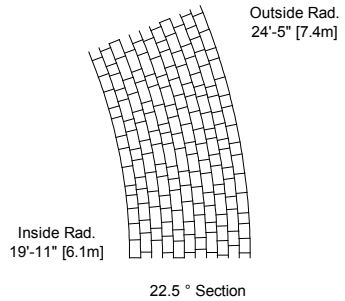

For all Arch Extensions:

SR-60

open sides

last wire on curve

Product No.
17-1-244

Description
Arch Extension #1

Brick Size
Random x 4⁷/₈"
(x 12.4cm)

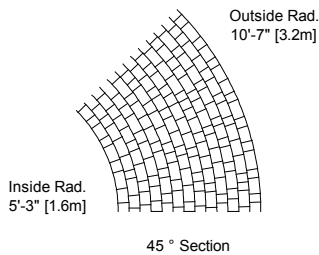

Product No.
17-1-273

Description
Arch Extension #5

Brick Size
Random x 4⁷/₈"
(x 12.4cm)

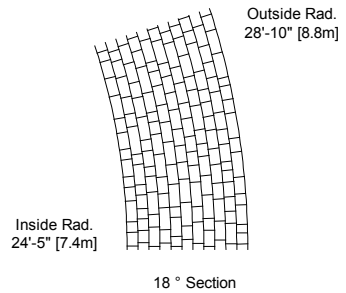

Product No.
17-1-245

Description
Arch Extension #2

Brick Size
Random x 4⁷/₈"
(x 12.4cm)

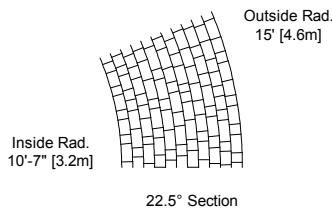

Product No.
17-1-274

Description
Arch Extension #6

Brick Size
Random x 4⁷/₈"
(x 12.4cm)

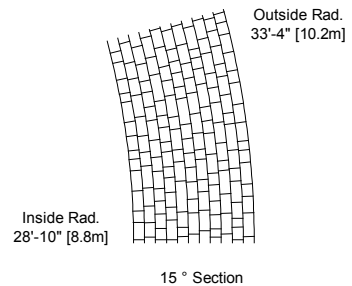

radial & arch extensions

Section 12.1

Product No.
17-1-275

Description
Arch Extension #7

Brick Size
Random x 4⁷/₈"
(x 12.4cm)

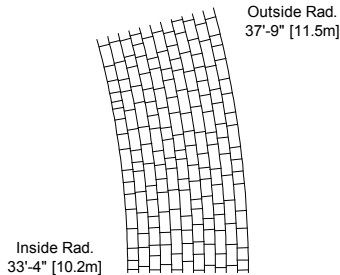

15 ° Section

Product No.
17-1-341

Description
Arch Extension #11

Brick Size
Random x 4⁷/₈"
(x 12.4cm)

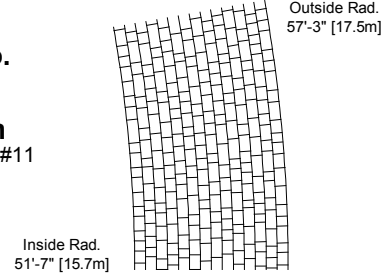

10 ° Section

Product No.
17-1-276

Description
Arch Extension #8

Brick Size
Random x 4⁷/₈"
(x 12.4cm)

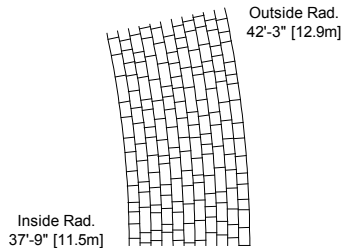

12 ° Section

Product No.
17-1-342

Description
Arch Extension #12

Brick Size
Random x 4⁷/₈"
(x 12.4cm)

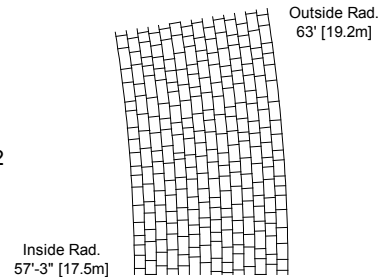

9 ° Section

Product No.
17-1-277

Description
Arch Extension #9

Brick Size
Random x 4⁷/₈"
(x 12.4cm)

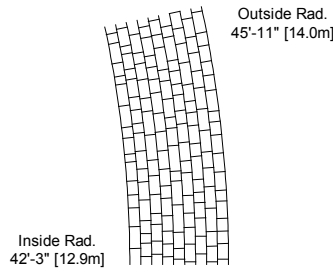

12 ° Section

Product No.
17-1-343

Description
Arch Extension #13

Brick Size
Random x 4⁷/₈"
(x 12.4cm)

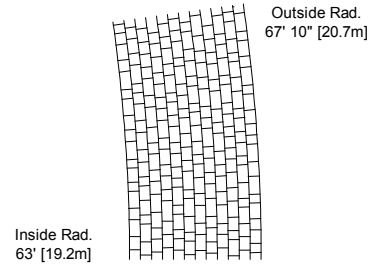

8 ° Section

Product No.
17-1-340

Description
Arch Extension #10

Brick Size
Random x 4⁷/₈"
(x 12.4cm)

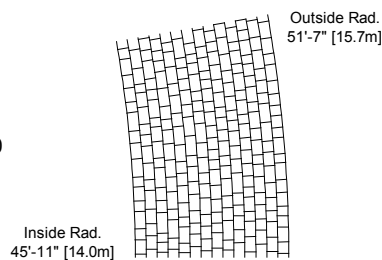

10 ° Section

Product No.
17-1-344

Description
Arch Extension #14

Brick Size
Random x 4⁷/₈"
(x 12.4cm)

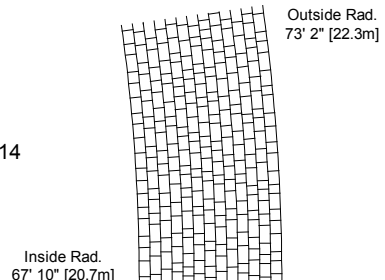

8 ° Section

numbers & letters

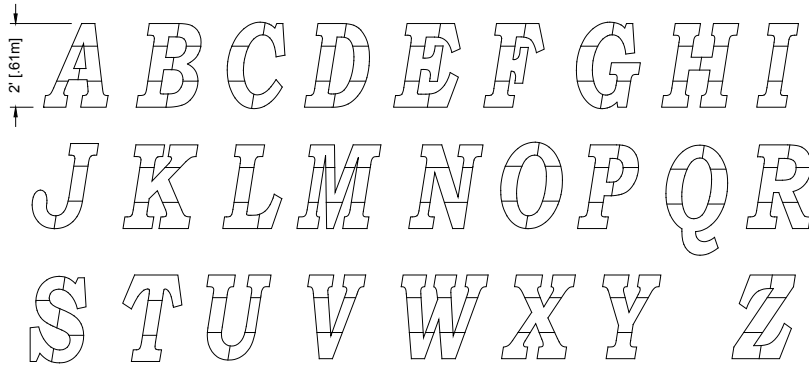

17-1-395 New Roman Letters - 24" tall

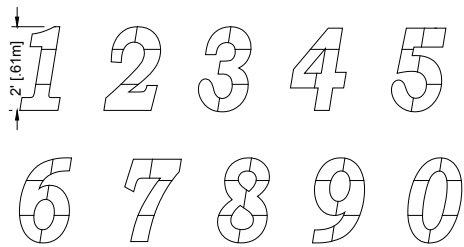

17-1-394 New Roman Numbers - 24" tall

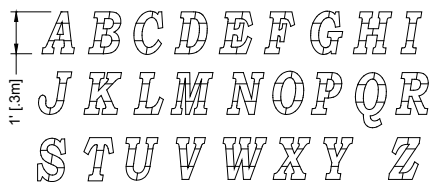

17-1-393 New Roman Letters - 12" tall



17-1-392 New Roman Numbers - 12" tall



17-1-391 Classic Letters - 12" tall

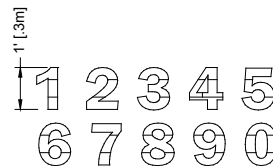

17-1-370 Classic Numbers - 12" tall

signage
playground

SR-60

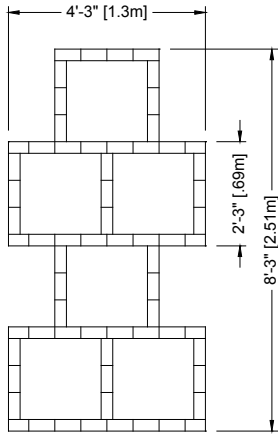

17-1-509 Hopscotch

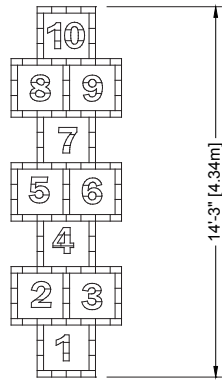

Finished Layout with
17-1-178 (12" Classic Numbers)

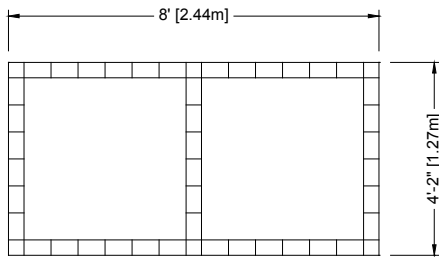

17-1-510 Four-Square

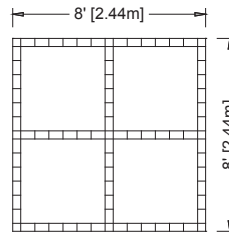

Finished Layout

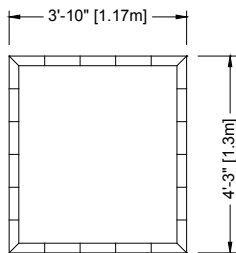

17-1-185 Signage Border

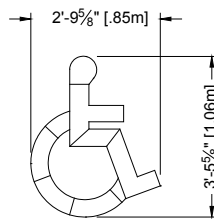

17-1-186 Wheelchair

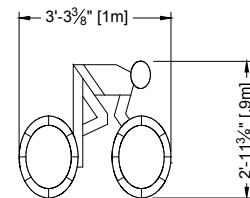

17-1-302 Bicycle

international templates

International templates are designed to match typical metric brick sizes

21 x 10 cm Brick Size

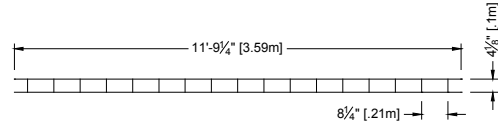
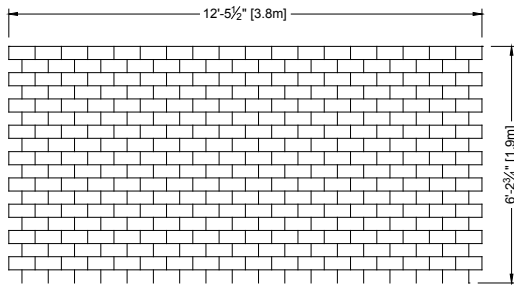

18-1-193 End-to-End Border

any SR 4" sides

10-113 Offset Brick

SR-120 12" sides all sides

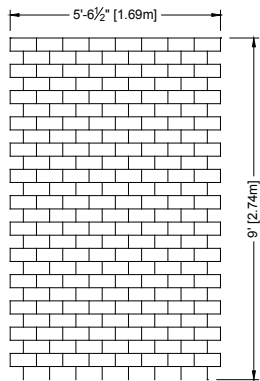

10-114 Offset Brick

SR-60 5" sides all sides

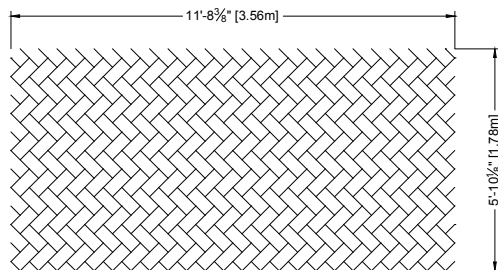

12-1-143 Diagonal Herringbone

SR-60 all sides all sides

(21 x 7 cm Brick Size)

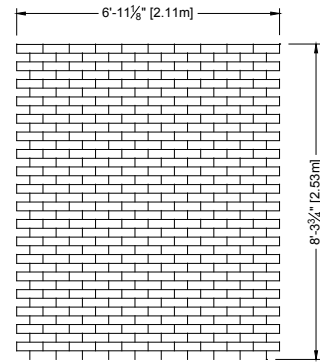

10-1-117 Offset Brick

SR-60 6" sides all sides

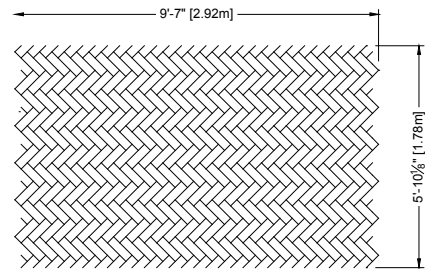

12-1-141 Diagonal Herringbone

SR-60 all sides all sides